

## SIGN DIVA TUBE SUSPENSION

### A300022-

|             |             |                   |                    |                     |                   |                    |
|-------------|-------------|-------------------|--------------------|---------------------|-------------------|--------------------|
| base number | LED Dimming | Color Temperature | Finishes (Diamond) | Finishes (Triangle) | Finishes (Circle) | Diffuser with Ring |
|-------------|-------------|-------------------|--------------------|---------------------|-------------------|--------------------|

- To build a product code in our configurator select the specify button on the base model # product page
- To build a manual product code on this datasheet choose from the options listed below in blue font and add the suffix to the base model #

#### GENERAL

Series: Sign Diva Tube  
 Subseries: Sign Diva Tube  
 Brand: Prolicht  
 Division: Architectural  
 Mounting Type: Suspension  
 Mounting Location: Ceiling  
 Subcategory: Pendant

#### PHYSICAL

Shape: Round  
 Diameter (mm): 570  
 Diameter (in): 22 7/16  
 Height (mm): 72  
 Height (in): 2 13/16  
 Max. Overall Height (mm): 2002  
 Max. Overall Height (in): 78 13/16  
 Light Distribution: Direct  
 Weight (kg): 7.718  
 Weight (lbs): 17.015

Diffuser: PMMA - Opal / Micro-Prism / Sparkling Secret / Vintage Industrial

Fixture Finish: SSR / BKV / CWI / CRY / HAB / UFT / ITA / RUA / FTG / MYG / LOD / PUS / FRO / FUP / KIA / POP / BLS / SPG / MEY / GOH / GUM / CHC / COM / ABZ / JAG / OBR / MOS / ROR

Fixture Material: Extruded Aluminum / Steel

#### ELECTRICAL

Lamp Type: LED (Zhaga Standard)  
 Input Wattage (W): 49  
 Total Output Wattage (W): 46.9  
 Dimming: Tri-Mode (Non-Dimming and Phase Dimming (120Vac only) and 0-10V Dimming)  
 Driver Included: Yes  
 Driver Location: Integrated  
 Driver Type: Constant Current - Universal  
 Driver Class: Class 2  
 Input Voltage (V): 120 - 277  
 Constant Current (MA): 350

#### LED

Color Temperature (°K): 2700 / 3000 / 3500 / 4000  
 Max. Delivered Lumen (lm): 4978 / 5337 / 5384 / 5494  
 Nominal Lumen (lm): 6199 / 6646 / 6705 / 6842  
 CRI: >90 CRI  
 Lamp Life (hrs): 50000

#### OPTICAL

#### RATINGS AND CERTIFICATIONS

Certified By: Certified for North American Standards  
 IP rating: IP20

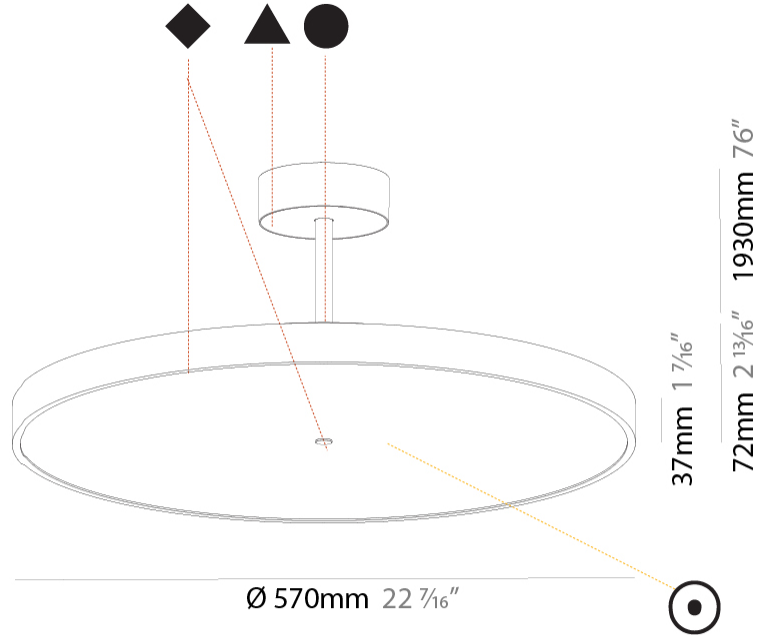

## SIGN DIVA TUBE SUSPENSION

A300022-

|           |       |
|-----------|-------|
| PROJECT   | _____ |
| TYPE      | _____ |
| SPECIFIER | _____ |
| QUANTITY  | _____ |
| DATE      | _____ |

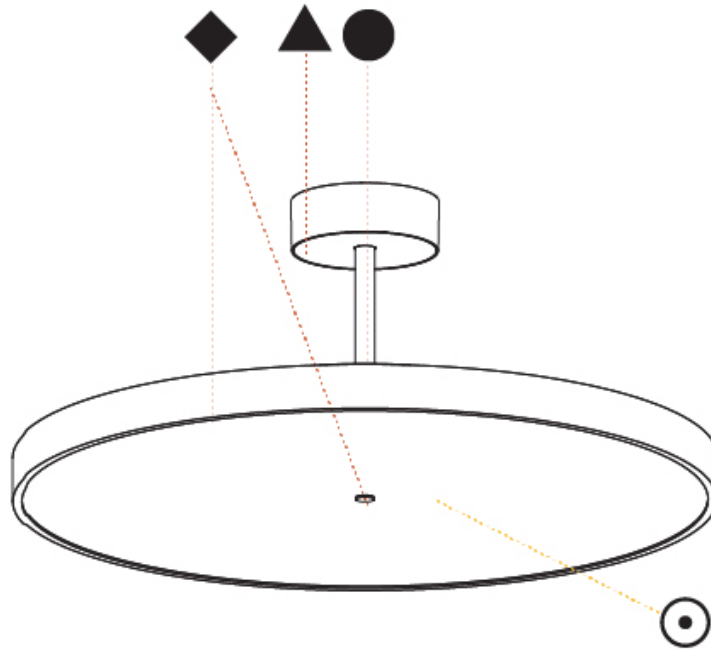

A

## SIGN DIVA TUBE SUSPENSION

### A300023-

base number LED Dimming Color Temperature Finishes (Diamond) Finishes (Triangle) Finishes (Circle) Diffuser with Ring

- To build a product code in our configurator select the specify button on the base model # product page
- To build a manual product code on this datasheet choose from the options listed below in blue font and add the suffix to the base model #

#### GENERAL

Series: Sign Diva Tube  
 Subseries: Sign Diva Tube  
 Brand: Prolicht  
 Division: Architectural  
 Mounting Type: Suspension  
 Mounting Location: Ceiling  
 Subcategory: Pendant

#### PHYSICAL

Shape: Round  
 Diameter (mm): 570  
 Diameter (in): 22 7/16  
 Height (mm): 72  
 Height (in): 2 13/16  
 Max. Overall Height (mm): 2002  
 Max. Overall Height (in): 78 13/16  
 Light Distribution: Direct / Indirect  
 Weight (kg): 8.533  
 Weight (lbs): 18.812  
 Diffuser: PMMA - Opal / Micro-Prism / Sparkling Secret / Vintage Industrial  
 Fixture Finish: SSR / BKV / CWI / CRY / HAB / UFT / ITA / RUA / FTG / MYG / LOD / PUS / FRO / FUP / KIA / POP / BLS / SPG / MEY / GOH / GUM / CHC / COM / ABZ / JAG / OBR / MOS / ROR  
 Fixture Material: Extruded Aluminum / Steel

#### ELECTRICAL

Lamp Type: LED (Zhaga Standard)  
 Input Wattage (W): 67  
 Dimming: Tri-Mode (Non-Dimming and Phase Dimming (120Vac only) and 0-10V Dimming)  
 Driver Included: Yes  
 Driver Location: Integrated  
 Driver Type: Constant Current - Universal  
 Driver Class: Class 2  
 Input Voltage (V): 120 - 277  
 Constant Current (MA): 350

#### LED

Color Temperature (°K): 2700 / 3000 / 3500 / 4000  
 Max. Delivered Lumen (lm): 6632 / 6728 / 6812 / 6951  
 Nominal Lumen (lm): 9097 / 9229 / 9344 / 9535  
 CRI: >90 CRI  
 Lamp Life (hrs): 50000

#### OPTICAL

#### RATINGS AND CERTIFICATIONS

Certified By: Certified for North American Standards  
 IP rating: IP20

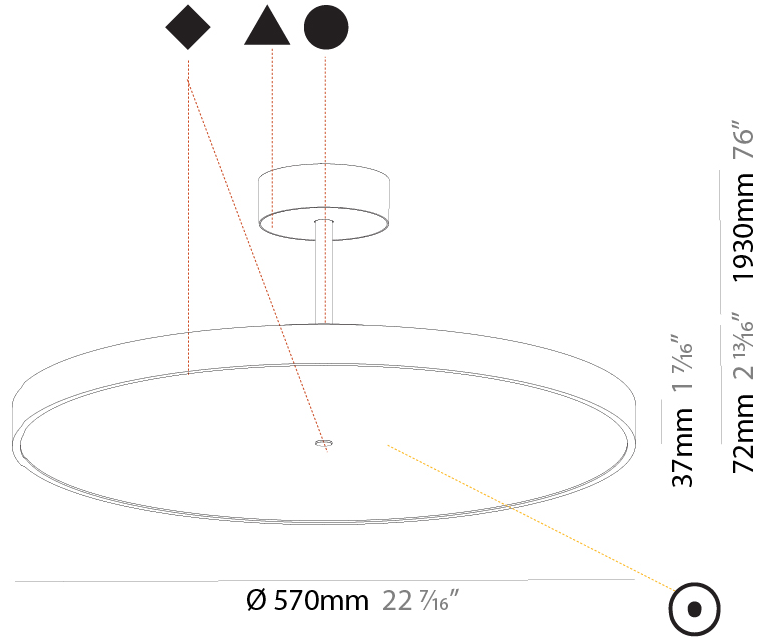

## SIGN DIVA TUBE SUSPENSION

A300023-

|           |       |
|-----------|-------|
| PROJECT   | _____ |
| TYPE      | _____ |
| SPECIFIER | _____ |
| QUANTITY  | _____ |
| DATE      | _____ |

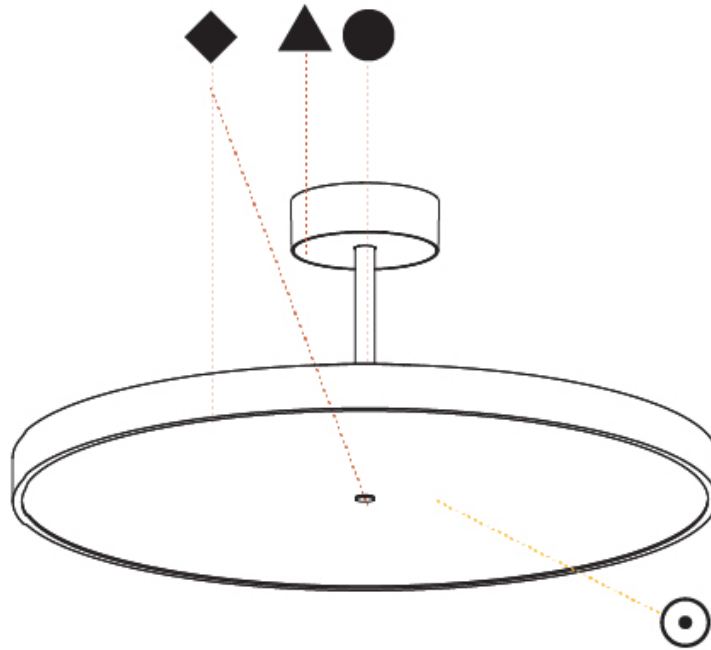

A

|           |
|-----------|
| PROJECT   |
| TYPE      |
| SPECIFIER |
| QUANTITY  |
| DATE      |

## SIGN DIVA TUBE KORONA SUSPENSION

### A300027-

|             |             |                   |                    |                     |                   |          |
|-------------|-------------|-------------------|--------------------|---------------------|-------------------|----------|
| base number | LED Dimming | Color Temperature | Finishes (Diamond) | Finishes (Triangle) | Finishes (Circle) | Diffuser |
|-------------|-------------|-------------------|--------------------|---------------------|-------------------|----------|

- To build a product code in our configurator select the specify button on the base model # product page
- To build a manual product code on this datasheet choose from the options listed below in blue font and add the suffix to the base model #

#### GENERAL

|                                  |
|----------------------------------|
| Series: Sign Diva Tube           |
| Subseries: Sign Diva Tube Korona |
| Brand: Prolicht                  |
| Division: Architectural          |
| Mounting Type: Suspension        |
| Mounting Location: Ceiling       |
| Subcategory: Pendant             |

#### PHYSICAL

|                                  |
|----------------------------------|
| Shape: Round                     |
| Diameter (mm): 570               |
| Diameter (in): 22 7/16           |
| Height (mm): 86                  |
| Height (in): 3 3/8               |
| Max. Overall Height (mm): 2016   |
| Max. Overall Height (in): 79 3/8 |
| Light Distribution: Direct       |
| Weight (kg): 7.982               |
| Weight (lbs): 17.597             |

Diffuser: [PMMA - Opal](#) / [Micro-Prism](#) / [Sparkling Secret](#) / [Vintage Industrial](#)

Fixture Finish: [SSR / BKV / CWI / CRY / HAB / UFT / ITA / RUA / FTG / MYG / LOD / PUS / FRO / FUP / KIA / POP / BLS / SPG / MEY / GOH / GUM / CHC / COM / ABZ / JAG / OBR / MOS / ROR](#)

Fixture Material: [Extruded Aluminum](#) / [Steel](#)

#### ELECTRICAL

|   |
|---|
| Lamp Type: LED (Zhaga Standard)   |
| Input Wattage (W): 49   |
| Total Output Wattage (W): 46.9  |
| Dimming: <a href="#">Tri-Mode (Non-Dimming and Phase Dimming (120Vac only) and 0-10V Dimming)</a> |
| Driver Included: Yes  |
| Driver Location: Integrated   |
| Driver Type: Constant Current - Universal   |
| Driver Class: Class 2   |
| Input Voltage (V): 120 - 277  |
| Constant Current (MA): 350  |

#### LED

|   |
|---|
| Color Temperature (*K): <a href="#">2700</a> / <a href="#">3000</a> / <a href="#">3500</a> / <a href="#">4000</a> |
| Max. Delivered Lumen (lm): 4978 / 5337 / 5384 / 5494  |
| Nominal Lumen (lm): 6199 / 6646 / 6705 / 6842   |
| CRI: >90 CRI  |
| Lamp Life (hrs): 50000  |

#### OPTICAL

#### RATINGS AND CERTIFICATIONS

|  |
|--|
| Certified By: Certified for North American Standards |
| IP rating: IP20                                      |

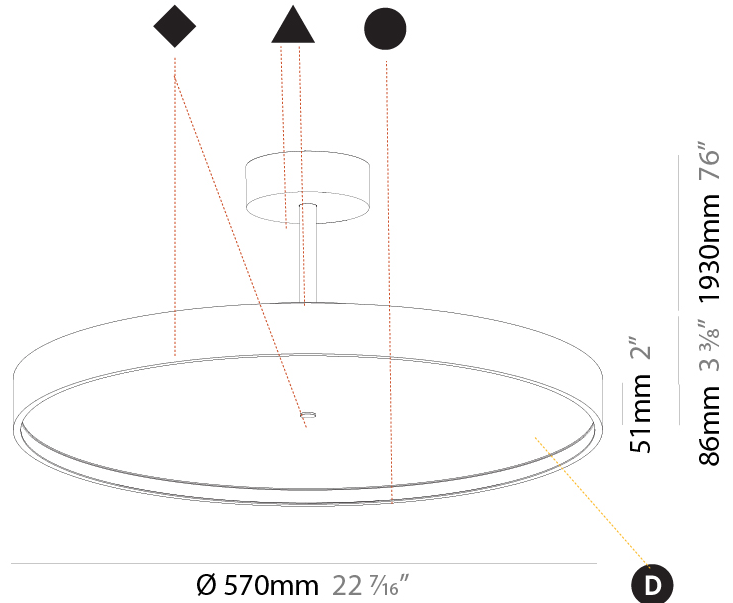

## SIGN DIVA TUBE KORONA SUSPENSION

A300027-

|           |       |
|-----------|-------|
| PROJECT   | _____ |
| TYPE      | _____ |
| SPECIFIER | _____ |
| QUANTITY  | _____ |
| DATE      | _____ |

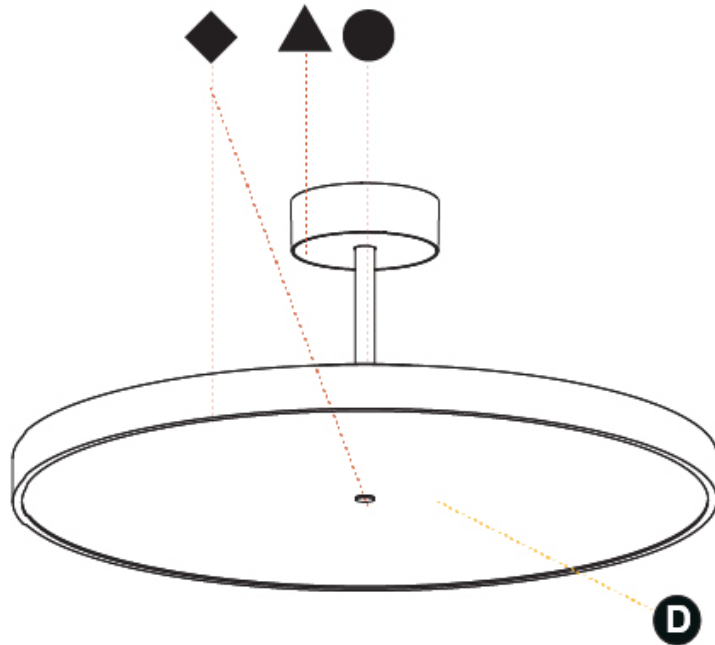

|           |
|-----------|
| PROJECT   |
| TYPE      |
| SPECIFIER |
| QUANTITY  |
| DATE      |

## SIGN DIVA TUBE KORONA SUSPENSION

### A300028-

|             |             |                   |                    |                     |                   |          |
|-------------|-------------|-------------------|--------------------|---------------------|-------------------|----------|
| base number | LED Dimming | Color Temperature | Finishes (Diamond) | Finishes (Triangle) | Finishes (Circle) | Diffuser |
|-------------|-------------|-------------------|--------------------|---------------------|-------------------|----------|

- To build a product code in our configurator select the specify button on the base model # product page
- To build a manual product code on this datasheet choose from the options listed below in blue font and add the suffix to the base model #

#### GENERAL

|                                  |
|----------------------------------|
| Series: Sign Diva Tube           |
| Subseries: Sign Diva Tube Korona |
| Brand: Prolicht                  |
| Division: Architectural          |
| Mounting Type: Suspension        |
| Mounting Location: Ceiling       |
| Subcategory: Pendant             |

#### PHYSICAL

|   |
|---|
| Shape: Round  |
| Diameter (mm): 570  |
| Diameter (in): 22 7/16  |
| Height (mm): 86   |
| Height (in): 3 3/8  |
| Max. Overall Height (mm): 2016  |
| Max. Overall Height (in): 79 3/8  |
| Light Distribution: Direct / Indirect   |
| Weight (kg): 8.797  |
| Weight (lbs): 19.394  |
| Diffuser: PMMA - Opal / Micro-Prism / Sparkling Secret / Vintage Industrial   |
| Fixture Finish: SSR / BKV / CWI / CRY / HAB / UFT / ITA / RUA / FTG / MYG / LOD / PUS / FRO / FUP / KIA / POP / BLS / SPG / MEY / GOH / GUM / CHC / COM / ABZ / JAG / OBR / MOS / ROR |
| Fixture Material: Extruded Aluminum / Steel   |

#### ELECTRICAL

|   |
|---|
| Lamp Type: LED (Zhaga Standard)   |
| Input Wattage (W): 67   |
| Dimming: Tri-Mode (Non-Dimming and Phase Dimming (120Vac only) and 0-10V Dimming) |
| Driver Included: Yes  |
| Driver Location: Integrated   |
| Driver Type: Constant Current - Universal   |
| Driver Class: Class 2   |
| Input Voltage (V): 120 - 277  |
| Constant Current (MA): 350  |

#### LED

|  |
|--|
| Color Temperature (°K): 2700 / 3000 / 3500 / 4000    |
| Max. Delivered Lumen (lm): 6632 / 6728 / 6812 / 6951 |
| Nominal Lumen (lm): 9097 / 9229 / 9344 / 9535        |
| CRI: >90 CRI   |
| Lamp Life (hrs): 50000                               |

#### OPTICAL

#### RATINGS AND CERTIFICATIONS

|  |
|--|
| Certified By: Certified for North American Standards |
| IP rating: IP20                                      |

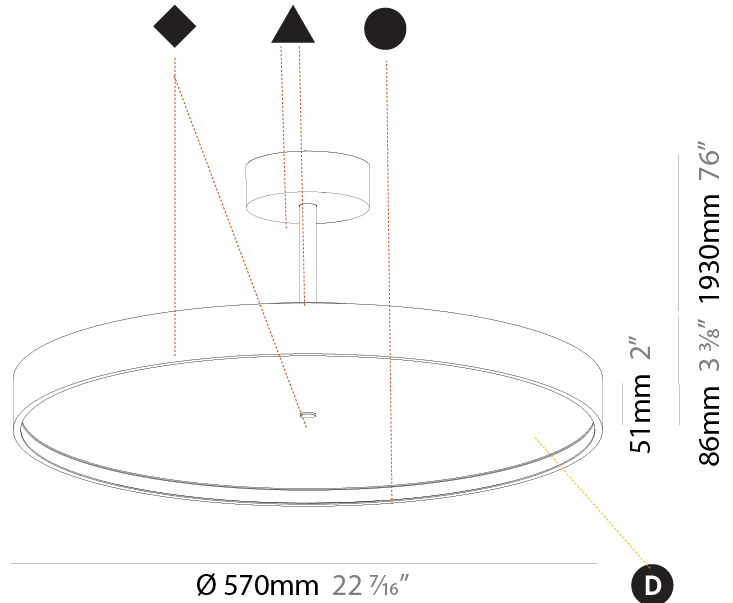

## SIGN DIVA TUBE KORONA SUSPENSION

A300028-

|           |
|-----------|
| PROJECT   |
| TYPE      |
| SPECIFIER |
| QUANTITY  |
| DATE      |

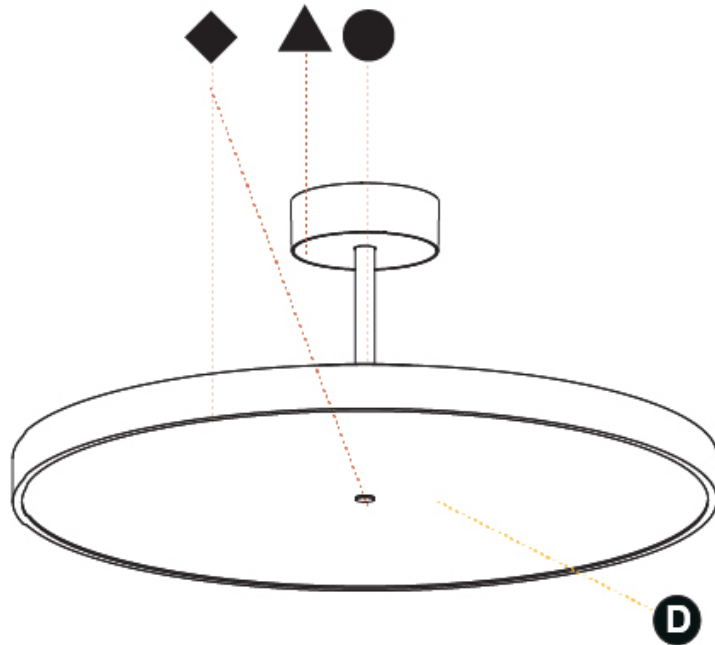

A



## SIGN DIVA TUBE COLOR FINISH CHART

|           |
|-----------|
| PROJECT   |
| TYPE      |
| SPECIFIER |
| QUANTITY  |
| DATE      |

### Fixture Finish

Sparkling Silver - 01 (SSR)



Black Velvet - 02 (BKV)



Crystal White - 03 (CWI)



Creamy - 04 (CRY)



Hampton Bay - 05 (HAB)



Urban Forest - 07 (UFT)



In the Army - 08 (ITA)



Rusty Angel - 09 (RUA)



Fade to Gray - 12 (FTG)



Mysterious Gray - 13 (MYG)



Lost Dream - 15 (LOD)



Purple Sky - 16 (PUS)



Fresh Oh - 17 (FRO)



Funky P. - 18 (FUP)



Kissing Aphrodite - 19 (KIA)



Poseidon's Paradise - 20 (POP)



Blue Sky - 21 (BLS)



Spring Green - 22 (SPG)



Mellow Yellow - 23 (MEY)



Golden Heart - 24 (GOH)



Gun Metal - 25 (GUM)



Champagne Cream - 26 (CHC)



Copper Mine - 27 (COM)



Ancient Bronze - 28 (ABZ)



Jazz Gold - 29 (JAG)



Olive Breeze - 30 (OBR)



Moonlight Silver - 31 (MOS)



Rosewood Red - 32 (ROR)



**Digital:** Not all screens are calibrated the same, and therefore, colors will appear differently between screens.





































































**Physical:** When texture is involved, there will be variations in color, character and tone within a product series and between product families.

**Gun Metal:** No Gun Metal finish is alike. It combines a mixture of transparent and black color particles which ensures a highly individual effect and no luminaire being identical.

**Champagne Cream, Copper Mine, Ancient Bronze + Jazz Gold:** These finishes have slight fading from specific powder coating production. Each luminaire will slightly vary.



### LEGEND

|  |   |   |  |   |  |
|--|---|---|--|---|--|
|    | floor-mounted   |    | pivotal  |    | special LED (upon request) RGB, RGBW, tunable, gold+, meat+, art+, fashion+                    |
|    | wall and ceiling: recessed and surface mounted            |    | rotating   |    | warm dim / natural dimming LED   |
|    | ceiling-mounted and wall-mounted                          |    | illuminate tilted  |    | rechargeable battery powered   |
|    | wall-mounted  |    | color of suspension cable                                    |    | fixture with natural vivid LED (upon request)  |
|    | omni-directional light distribution                       |    | length of suspension cable                                   |    | color rendering index  |
|    | direct light distribution                                 |    | reflector degree selection                                   |    | color temperature  |
|    | direct/indirect light distribution                        |    | super spot   |    | lumen (luminous flux)  |
|    | indirect light distribution                               |    | lens   |    | efficacy (lumens per watt)   |
|    | asymmetric light distribution                             |    | lens pack  |    | Unified Glare Rating (UGR) range from 5-40   |
|    | aura light distribution                                   |    | shine ring   |    | marine grade (AISI 316 stainless steel)  |
|    | round wall or ceiling cut-out                             |    | integrated shine ring with diffuser                          |    | walk on  |
|    | square wall or ceiling cut-out                            |    | free individual colors 01-29                                 |    | drive on   |
|    | the supplied jig specifies the cutout dimensions          |    | individual colors: 00 (free of charge), 01-25 (extra charge) |    | Dark Sky Compliance  |
|    | minimum distance (meters) lamp - object                   |    | luminaire part to be colored (F1)                            |    | Americans with Disabilities Act (less than 4" off the wall located between 27"-84" from floor) |
|    | recessed depth  |    | luminaire part to be colored (F2)                            |    | lamp protected against explosion   |
|   | ceiling thickness in mm                                   |   | luminaire part to be colored (F3)                            |   | blown glass using traditional methods by master glass blower                                   |
|  | ceiling thickness selection                               |  | luminaire part to be colored (F4)                            |  | acoustic material  |
|  | dimmable DP (phase), DV (0-10V), DD (dali), DS (step-dim) |  | luminaire part to be colored (F5)                            |  | protection class I, protection insulation  |
|  | included or excluded LED driver/transformer/control gear  |  | color of 3-circuit adaptor                                   |  | protection class II, protection insulation   |
|  | separately switchable                                     |  | indirect diffuser  |  | ETL Certified to UL and CSA Standards  |
|  | sensor  |  | direct diffuser  |  | UL Certified to UL and CSA Standards   |
|  | remote control  |  | ball-proof (upon request)                                    |  | CSA Certified to UL and CSA Standards  |
|  | available upon request                                    |  | accessory  |  | Certified for North American Standards   |

### IP RATING

|   |  |
|---|--|
|  | protected against ingress of solid bodies greater than 12.5mm (finger)   |
|  | protected against ingress of solid bodies greater than 2.5mm<br>protected against sprays of water up to 60 degrees from the vertical (rain)      |
|  | protected against ingress of solid bodies greater than 1mm (wire)<br>no protection against the ingress of moisture                               |
|  | protected against ingress of solid bodies greater than 1mm (wire)<br>protected against sprays of water up to 60 degrees from the vertical (rain) |
|  | protected against ingress of solid bodies greater than 1mm (wire)<br>protected against water splashed from all directions                        |
|  | protected against limited ingress of dust (wet rooms/covered outdoor areas)<br>protected against water splashed from all directions              |
|  | protected against ingress of dust<br>protected against jets of water   |
|  | protected against ingress of dust<br>protected against powerful jets of water or heavy seas  |
|  | protected against ingress of dust<br>protected against immersion of water between 15cm - 1m for 30 minutes                                       |
|  | protected against ingress of dust<br>protected against immersion of water under pressure for long periods  |

### IK RATING

|   |   |
|---|---|
|  | protected against 0.14 joules impact (equivalent to 0.25kg mass dropped from 56mm above the surface)  |
|  | protected against 0.2 joules impact (equivalent to 0.25kg mass dropped from 80mm above the surface)   |
|  | protected against 0.35 joules impact (equivalent to 0.25kg mass dropped from 140mm above the surface) |
|  | protected against 0.5 joules impact (equivalent to 0.25kg mass dropped from 200mm above the surface)  |
|  | protected against 0.7 joules impact (equivalent to 0.25kg mass dropped from 280mm above the surface)  |
|  | protected against 1 joules impact (equivalent to 0.25kg mass dropped from 400mm above the surface)    |
|  | protected against 2 joules impact (equivalent to 0.5kg mass dropped from 400mm above the surface)     |
|  | protected against 5 joules impact (equivalent to 1.7kg mass dropped from 300mm above the surface)     |
|  | protected against 10 joules impact (equivalent to 5.0kg mass dropped from 200mm above the surface)    |
|  | protected against 20 joules impact (equivalent to 5.0kg mass dropped from 400mm above the surface)    |